

# LOJ-A5-120 LED Street Light



## LED STREET LIGHT SPECIFICATION

Model No.	LOJ-A5-120-CT2-1	LOJ-A5-120-NT2-1	LOJ-A5-120-WT2-1
Input Voltage	AC 200~277(Vac)		
Frequency	50/60(Hz)		
LED Qty	48(pcs)		
Rated Power	120±10%(W)		
Luminous Flux	12075(lm)	11500(lm)	9200(lm)
Color Temp.(CCT)	6500K±500K	4000K±500K	3000K±500K
CRI	Ra>70		
Power Factor	>0.9		
Operating Ambient Temp.	-35°C~50°C		
Operating Ambient Humidity	10%~90%(RH)		
Life time(L70)	≥ 50000(HR)		
Architecture	Aluminum Base		
Dimensions (mm)	645(L)*340(W)*90(H)		
Weight	8.5±0.5(kg)		
Waterproof	IP66		

**Distribution Plot**

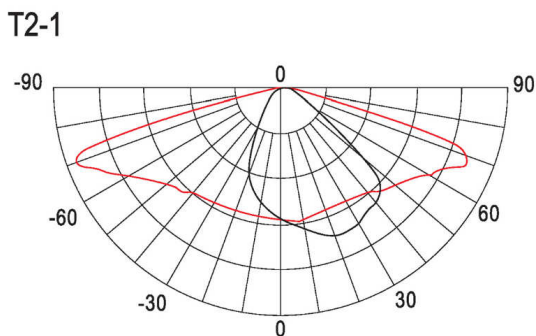

**Outline Dimensions**

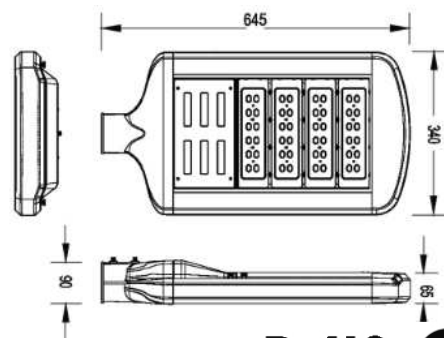

**RoHS** **CE**

**Remarks**

- 1.The tolerance of luminous flux is ±10%.
- 2.The dimension tolerance is ±5mm.
- 3.The appearance and specifications of the product may be modified for improvement without notice.
- 4.All parameters of products are based on the measurement of Laster Tech laboratory.